

OFFICIAL WARWICK AMP OWNER MANUAL



ENGLISH

SAFETY HINTS

- Read these instructions
- Keep these instructions
- Heed all warnings
- Follow these instructions



Caution: To reduce the risk of electric shock, do not open the amplifier's case. Avoid exposure to rain or moisture. No user serviceable parts inside, refer all service to a qualified technician. No vessel filled with liquids, such as vases shall be placed on top of the unit.

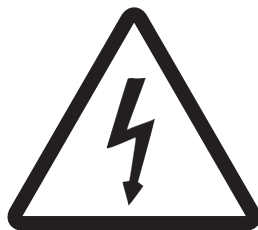

This symbol, wherever it appears, alerts you to the presence of dangerous non-insulated voltage inside the case. Risk of electric shock!



This symbol, wherever it appears, indicates to important operating and maintenance instructions in this user manual. Please read the manual.



This recycling logo informs the end user that it is forbidden to throw away the product in the trash. It has to be disposed of accordingly.

Weee-Nr.: DE93670540



CB Approved

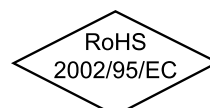

Congratulations on the purchase of the new Warwick amplifier head/combo. Please read through these instructions before connecting and operating the device. If you keep to the guidelines set out in this manual, you will soon be able to appreciate the quality of this new Warwick amplifier. Please keep this instruction booklet handy in case you need to consult it again. Please send the PASSPORT to the address indicated therein.

RECOMMENDATIONS

The following recommendations are designed to ensure that the device always functions reliably:

- Never open the casing! To do so would expose you to the risk of an electric shock. Should repairs prove necessary, leave them to qualified service personnel.
- Avoid dust and high moisture levels, direct sunlight and extremely high or low temperature.
- Safeguard the device from excessive vibration. Always place the unit on a stable and horizontal surface.
- See to adequate ventilation. The device should not be placed on soft surfaces (carpet, cushions, etc.). When mounting it in a rack, make sure that the rear and lateral cooling vents remain unobstructed.
- Avoid leaving the unit near radiators or other objects producing heat.
- Internal components should only be adjusted or cleaned by qualified service technicians. Ensure no object or liquid penetrates the device through its cooling vents.
- When replacing a fuse make sure you fit in one of identical value!

Have the device examined by a qualified service technician in the following cases:

- the mains lead or mains switch have been damaged,
- objects or liquids have penetrated the device,
- it has been exposed to excessive moisture,
- malfunctions or abnormal operating conditions have occurred,
- the device has been dropped or the casing damaged.

HINTS

- This apparatus shall not be exposed dripping or splashing and that no objects filled with liquids, such as vases, shall be placed on the apparatus.
- This apparatus should be connected to a MAINS socket outlet with a protective earthing connection.
- Mains plug or appliance connector shall be used as the disconnect device, so mains plug or appliance connector should always remain readily operable.
- If the apparatus shows any malfunction, immediately disconnect the main power cord from the mains socket.
- Do only operate effects pedals in-between the instrument and the amplifier, as these devices are not designed for the supplied load of an effects loop.
- Remove the plug whenever changing a fuse.
- Only ever replace a fuse with another of the same type. Never bridge defective fuses.
- Make sure the top and bottom of the device are properly ventilated and that the vents are not blocked.
- Do not subject the device to excessive vibration or hard jolts as these could damage the device.
- Don't undertake repairs yourself.
- Only allow the case to be opened by qualified personnel. (Remove the plug).
- Repairs should only be undertaken by qualified personnel.

SHOULD YOU FIND YOURSELF ONE DAY WONDERING: "WHY IS THERE NO SOUND COMING OUT?"

please check:

- all stub cables,
- all connections of these cables

and proceed anew by following the guidelines of the chapter GETTING STARTED. Possibly the problem reveals to be an operational error.



PROTECTIVE CIRCUITS

Your new Warwick amplifier is equipped with a series of circuits to prevent it from destruction in case of inadequate operating conditions:

- Power-up delay:** When the unit is switched on, the **SPEAKER OUT** sockets are activated with a slight delay to protect the loudspeakers.
- Short-circuit:** In the event of a short-circuit at the power amp outputs, this feature prevents the output stage transistors from destruction by quickly reducing current.
- Direct current (DC):** This circuit continuously monitors the power amp output for direct current and protects the loudspeakers from overload should a transistor burn out.
- HF oscillation:** By switching the power amp off, this safety feature prevents from damages that could be caused by frequencies in excess of 20 kHz (feedback, etc.).
- Excessive temperatures:** Should the temperature-regulated fan cooler prove to be insufficient in extreme conditions, this circuit protects the output stage transistors from destruction by switching the device off.
- Note:** Note: You can recognise that one of these circuits has been activated as a result of a fault, when the **MUTE LED** glows continuously even though you have not selected the MUTE mode. In case of a shortcircuit please check the speaker cable. The amplifier must then be switched off and on again, to get back into playing mode after having removed the short-circuit. In any other situation on the amplifier switches automatically back to playing mode as soon as it detects the fault has disappeared (e.g. the amplifier has overheated and cooled down again).

GETTING STARTED

1. Make sure that loudspeakers capable of sustaining the load of a bass signal are connected to the **SPEAKER OUT** sockets (the speaker cables should meet a cross-section of at least 2 x 1.5 mm).
2. Check that the mains supply has been plugged in and that all external (effects) units possibly used are correctly connected and operational.
3. Set the **MASTER** control to zero.
4. Plug your bass guitar into the amplifier's **INPUT** with a shielded line-cable.
5. Press the **POWER** switch to turn the device on.
6. Switch **MUTE** off and the red LED will extinguish.
7. Switch the **COMPRESSOR** off (the 2-coloured LED will extinguish).
8. Turn all volume controls of your bass guitar on to their maximum.
9. Adjust the **GAIN** control until the (loudly) played bass signal flashes the Clip LED.
10. Set the **MASTER** control to the volume you wish to play at.
11. Adjust the sound that you wish with the controls and switches described in the respective chapters **FRONT PANEL CONTROLS**.
12. If necessary readjust **GAIN**.

FRONT PANEL CONTROLS

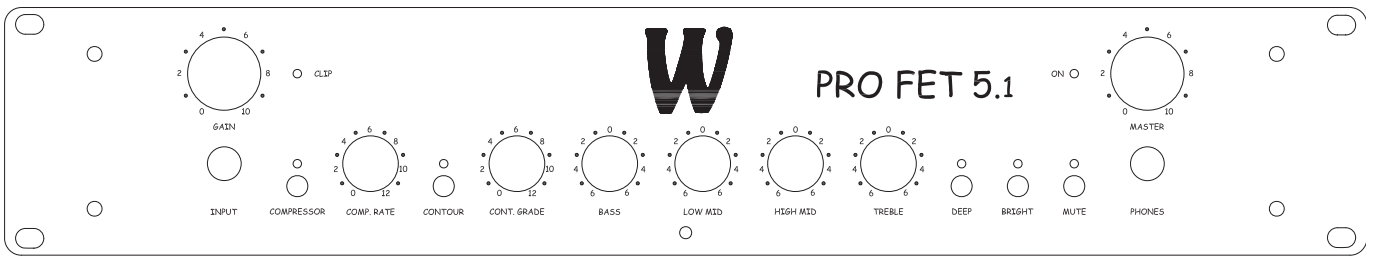

- INPUT** Socket to plug in a bass guitar.
- GAIN** Control + CLIP LED to adjust the input level.
- COMPRESSOR** Switch to activate the compressor control to adjust the level of compression.
- CONTOUR** Switch to activate the contour control to adjust the level of the contour (bass- and treble boost and mid cut)
- BASS** Control to boost/cut deep frequencies.
- LOW MID** Control to boost/cut low mids.
- HIGH MID** Control to boost/cut high mids.
- TREBLE** Control to boost/cut high frequencies.
- DEEP** Control to boost/cut high mids.
- BRIGHT** Control to boost/cut high frequencies.
- MASTER** Control determines the mains level.
- MUTE** Switch + **ON/MUTE LED** cuts the signal from all outputs, except from the PHONES socket and leads the signal to the TUNER OUT socket.
- PHONES** Socket for connecting a headphone (min 200 Ω).

REAR PANEL

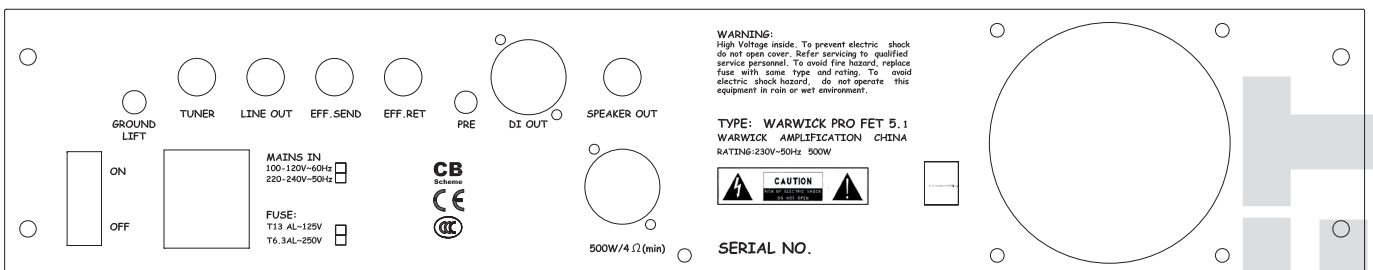

- POWER** Switch for turning the amplifier on and off.
- MAINS IN AC** Terminal with integrated fuse compartment for connecting the amplifier to the current network.
- GROUNDLIFT** Switch isolates the earth connection from the ground of the signal. Should several devices be simultaneously connected to earth by the same conductor as well as via line connections, a so called hum loop might appear. In this case operate GROUND LIFT to eliminate the current hum (when pressed).
- TUNER OUT** Socket for the connection of a tuner. When MUTE mode is activated, the unmodified bass signal is retained here.
- LINE OUT** Socket allows to connect additional power amplifiers or active cabinets.
- EFF. LOOP** For the insertion of effects units. Connect SEND with the input and RETURN with the output of the effects device.
- DI PRE/POST** Switches the signal lying at the DI OUT socket.
- DI OUT** Socket, PRE (pressed) unmodified bass signal, or POST (unpressed) bass signal treated by the tone controls and possibly by connected effect devices.
- SPEAKER OUT** Socket for connecting the loudspeaker.

FRONT PANEL CONTROLS

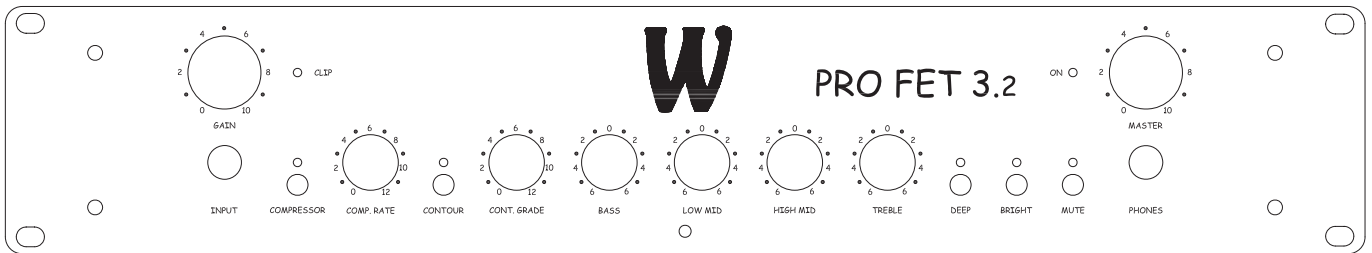

- INPUT** Socket to plug in a bass guitar.
- GAIN** Control + **CLIP LED** to adjust the input level.
- COMPRESSOR** Switch to activate the compressor control to adjust the level of compression.
- CONTOUR** Switch to activate the contour control to adjust the level of the contour (bass- and treble boost and mid cut)
- BASS** Control to boost/cut deep frequencies.
- LOW MID** Control to boost/cut low mids.
- HIGH MID** Control to boost/cut high mids.
- TREBLE** Control to boost/cut high frequencies.
- DEEP** Control to boost/cut high mids.
- BRIGHT** Control to boost/cut high frequencies.
- MASTER** Control determines the mains level.
- MUTE** Switch + **ON/MUTE LED** cuts the signal from all outputs, except from the PHONES socket and leads the signal to the TUNER OUT socket.
- PHONES** Socket for connecting a headphone (min 200 Ω).

REAR PANEL

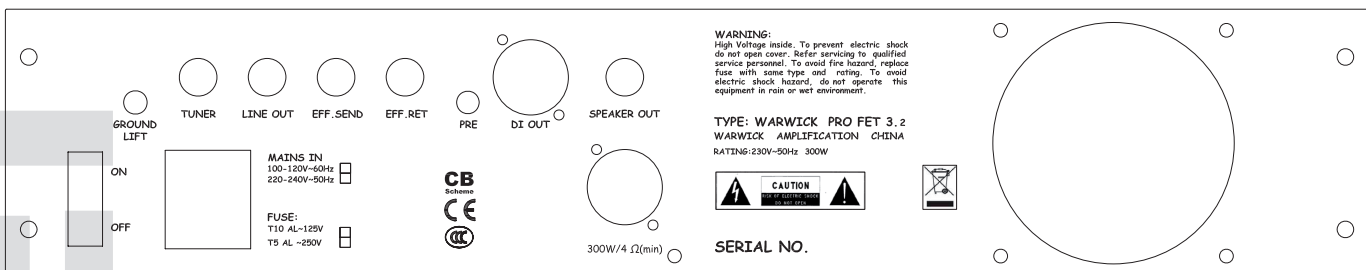

- POWER** Switch for turning the amplifier on and off.
- MAINS IN AC** Terminal with integrated fuse compartment for connecting the amplifier to the current network.
- GROUNDLIFT** Switch isolates the earth connection from the ground of the signal. Should several devices be simultaneously connected to earth by the same conductor as well as via line connections, a so called hum loop might appear. In this case operate GROUND LIFT to eliminate the current hum (when pressed).
- TUNER OUT** Socket for the connection of a tuner. When MUTE mode is activated, the unmodified bass signal is retained here.
- LINE OUT** Socket allows to connect additional power amplifiers or active cabinets.
- EFF. LOOP** For the insertion of effects units. Connect SEND with the input and RETURN with the output of the effects device.
- DI PRE/POST** Switches the signal lying at the DI OUT socket.
- DI OUT** Socket, PRE (pressed) unmodified bass signal, or POST (unpressed) bass signal treated by the tone controls and possibly by connected effect devices.
- SPEAKER OUT** Socket for connecting the loudspeaker.

TECHNICAL DATA - PROFET 3.2 / 5.1

Input	25 mV																				
Preamp	transistor, active controlled																				
Poweramp	fan cooled (non permanent)																				
Equalizer	<table> <tr> <td>Bass</td> <td>±12dB @ 80Hz</td> </tr> <tr> <td>Low Mid</td> <td>±12dB @ 200Hz</td> </tr> <tr> <td>Hi Mid</td> <td>±12dB @ 600Hz</td> </tr> <tr> <td>Treble</td> <td>±14dB @ 5kHz</td> </tr> <tr> <td>Deep</td> <td>+12dB @ 30Hz</td> </tr> <tr> <td>Bright</td> <td>+8dB @ 3kHz</td> </tr> <tr> <td></td> <td>+14dB @ 16kHz</td> </tr> <tr> <td>Contour</td> <td>+20dB @ 20Hz</td> </tr> <tr> <td></td> <td>-10dB @ 300Hz</td> </tr> <tr> <td></td> <td>+12dB @ 10kHz</td> </tr> </table>	Bass	±12dB @ 80Hz	Low Mid	±12dB @ 200Hz	Hi Mid	±12dB @ 600Hz	Treble	±14dB @ 5kHz	Deep	+12dB @ 30Hz	Bright	+8dB @ 3kHz		+14dB @ 16kHz	Contour	+20dB @ 20Hz		-10dB @ 300Hz		+12dB @ 10kHz
Bass	±12dB @ 80Hz																				
Low Mid	±12dB @ 200Hz																				
Hi Mid	±12dB @ 600Hz																				
Treble	±14dB @ 5kHz																				
Deep	+12dB @ 30Hz																				
Bright	+8dB @ 3kHz																				
	+14dB @ 16kHz																				
Contour	+20dB @ 20Hz																				
	-10dB @ 300Hz																				
	+12dB @ 10kHz																				
Compressor	adjustable																				
Headphone	200 ohms min.																				
Direct Out	0dB, 600 ohms																				
Effects Loop	mono serial send 0dB, 600 ohms return 0dB, 10k ohms																				
Switches	Groundlift, DI pre/post																				
Speaker Out	jack and lockable coaxial 300W/4 ohms (Profet 3.2) 500W/4 ohms (Profet 5.1)																				
THD	< 0.1 %																				
Weight	8.5 kg (Profet 3.2) 10.0 kg (Profet 5.1)																				
Dimensions	19" / 483 x 90 x 350 (w*h*d)																				

DIAGRAM - PROFET 3.2 / 5.1

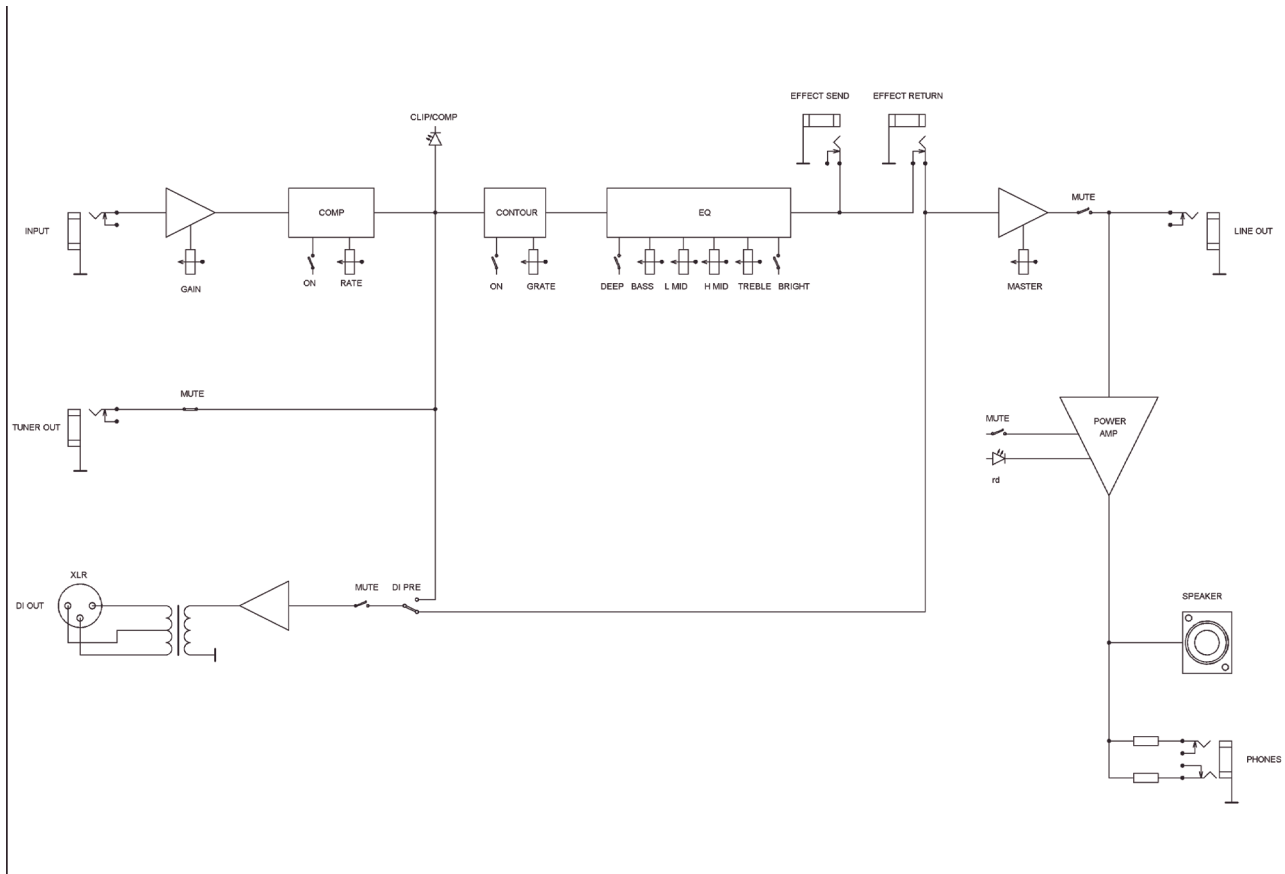

CONNECT SPEAKERS - PROFET 3.2 / 5.1

Note: The minimum load of the power amplifier is 4 ohms.

Speaker Set-up	
Quantity	Impedance
4	16 ohms Cabinets
2	8 ohms Cabinets
1	6 ohms Cabinet
1	4 ohms Cabinet

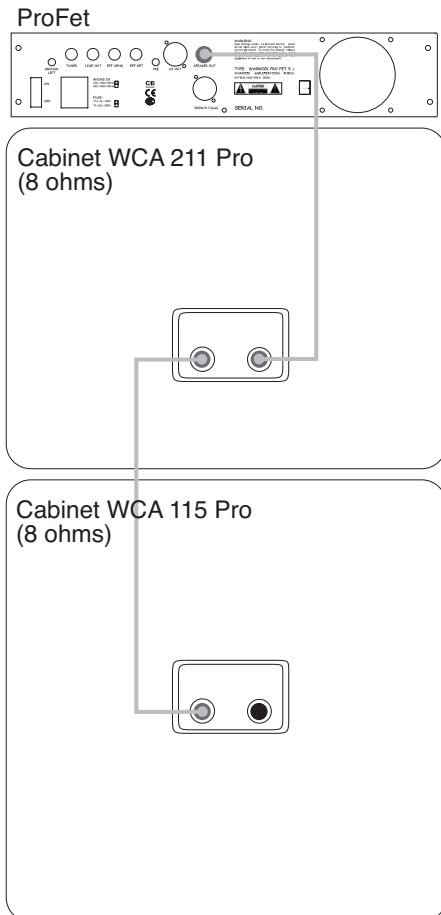

**Please see the new Warwick Bass Forum on www.warwick.de
For support information please refer to support@warwick.de**

**Visite por favor el nuevo forum Warwick de bajo en www.warwick.de
Para soporte técnico e información, dirigirse por favor a support@warwick.de**

**Por favor veja o novo Fórum de Baixos da Warwick em HYPERLINK www.warwick.de
Para mais informações escreva para HYPERLINK support@warwick.de**

**Visitare il nuovo Forum Warwick Bass: www.warwick.de
Per supporto tecnico: support@warwick.de**

**Veillez consulter le nouveau forum sur les basses Warwick à l'adresse www.warwick.de
Si vous avez besoin de plus d'informations contactez support@warwick.de**

**Das neue Warwick Bass Forum finden Sie auf www.warwick.de
Bei technischen Fragen wenden Sie sich bitte an support@warwick.de**

ワーウィック・ウェブサイトへお越してください。HYPERLINK "<http://www.warwick.de>"
リニューアルしたワーウィックベースフォーラムをご覧ください。
サポート情報などは HYPERLINK "<mailto:support@warwick.de>" へお寄せください。

인터넷 홈페이지 : <http://www.warwick.de>
새로운 Warwick 베이스 포럼을 참고하시려면 www.warwick.de에 방문하십시오.
고객 지원을 받으시려면 support@warwick.de에 메일을 보내십시오.

请登录 HYPERLINK "<http://www.warwick.de>" 浏览握威贝司全新论坛
有任何问题 请发邮件至 HYPERLINK "<mailto:support@warwick.de>"

Nov Warwick Bass Forum najdete na webov?ch stránkách: HYPERLINK "<http://www.warwick.de>"
Můžete-li nějaké technické dotazy, pište na: support@warwick.de

Headquarters:
Branch China:
Branch UK:
Branch Switzerland:
Branch CZ/SK:
Branch PL:

Warwick GmbH&Co. Music Equipment KG • Gewerbepark 46 • 08258 Markneukirchen/Germany • E-Mail: info@warwick.de
Warwick Music Equipment (Shanghai) Ltd., Co. • Shanghai Waigaoqiao Free Trade Zone • Shanghai 200131/P.R.China • E-Mail: info@warwick.cn
Warwick Music Equipment Trading (Manchester UK) Ltd. • 75 Bridge Street • Manchester M3 2RH / Great Britain • E-Mail: info@warwickbass.co.uk
Warwick Music Equipment Trading (Zurich) GmbH • Kriesbachstrasse 30 • 8600 Dübendorf / Switzerland • E-Mail: info@warwick.ch
Warwick Music Equipment Trading (Praha CZ) s.r.o. • Spálená 23/93 • 11000 Praha 1 / Czech Republic • E-Mail: info@warwick.cz
Warwick Music Equipment Trading (Warsaw) Sp. z o.o. • Flory 7/18a • 00-586 Warsaw / Poland • E-Mail: info@warwick.pl

Visit us on the World Wide Web: <http://www.warwick.de> & join us in WARWICK BASS FORUM: www.warwick.de/forum

